

AP1010

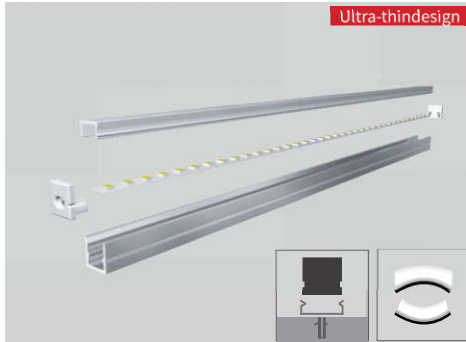

 Silver

Material: AL6063-T5
Surface: Anodized
PC cover: Opal
Lighting source width: 8 mm
Available lengths: 0.5-3m
Application: Cabinet lighting / Wardrobe lighting

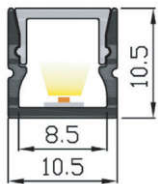

COVER



END CAP



CLIP



AP1815

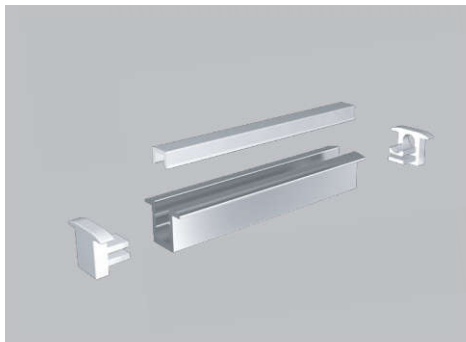

 Silver

Material: AL6063-T5
Surface: Anodized
PC cover: Opal
Lighting source width: 8mm
Available lengths: 0.5- 3m
Application: Cabinet lighting / Wardrobe lighting

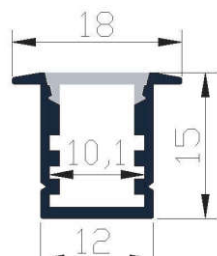

COVER



END CAP



CLIP

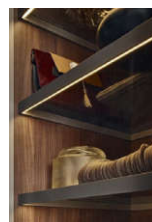

AP1707

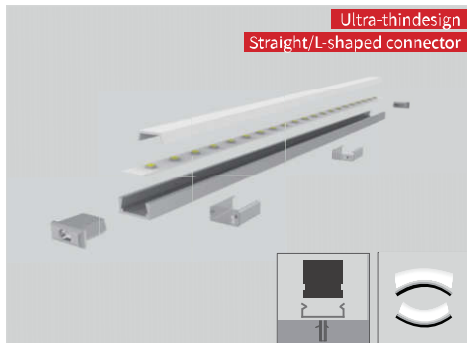

BLACK Available

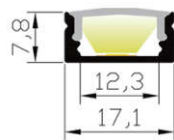

Silver

Material: AL6063-T5
 Surface: Anodized
 PC cover: Opal
 Lighting source width: 12mm
 Available lengths: 0.5- 3m
 Application: Cabinet lighting / Wardrobe lighting

COVER



END CAP



CLIP

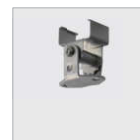

AP1612N



Silver

Material: AL6063-T5
 Surface: Anodized
 PC cover: Opal
 Lighting source width: 10mm
 Available lengths: 0.5- 3m
 Application: Cabinet lighting / Wardrobe lighting

COVER



END CAP



CLIP

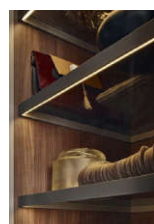
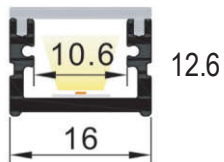

AP1208

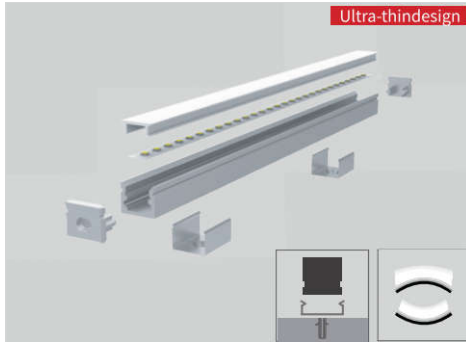

Silver

Material: AL6063-T5
 Surface: Anodized
 PC cover: Opal
 Lighting source width: 12mm
 Available lengths: 0.5- 3m
 Application: Cabinet lighting / Wardrobe lighting

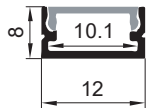

COVER

END CAP

CLIP



AP2520

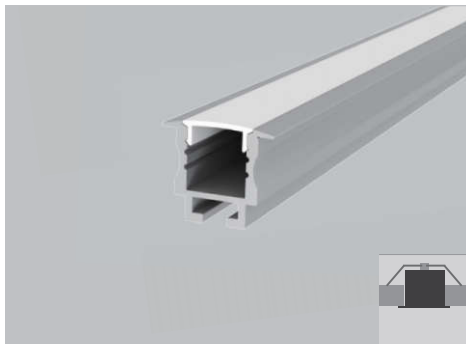

Silver

Material: AL6063-T5
 Surface: Anodized
 PC cover: Opal
 Lighting source width: 10mm
 Available lengths: 0.5- 3m
 Application: Cabinet lighting / Wardrobe lighting

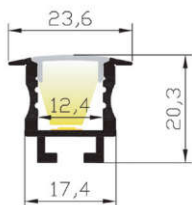

COVER

END CAP

RECESSED CLIP



AP1715



Silver
 Black
 White

Material: AL6063T5
Surface: Anodized/ Painting
PC cover: Diffuser/Transparent/Opal
Lighting source width: 12 mm
Available lengths: 0.5-3m
Application: Commercial lighting / Indoor lighting
 Decorative design

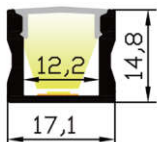

COVER



END CAP



CLIP

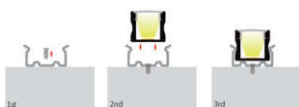

AP2515

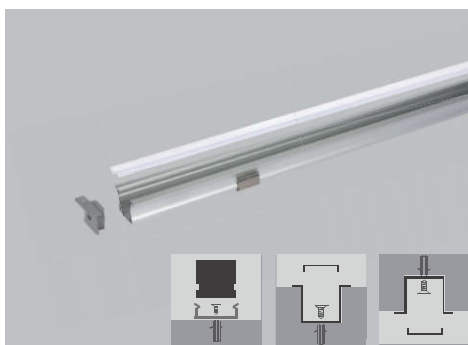

Silver
 Black

Material: AL6063T5
Surface: Anodized/ Painting
PC cover: Diffuser/Transparent/Opal
Lighting source width: 12 mm
Available lengths: 0.5-3m
Application: Commercial lighting / Indoor lighting
 Decorative design



BLACK is available

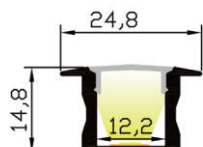

COVER



END CAP



CLIP

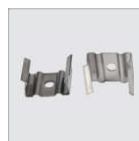

AP1616

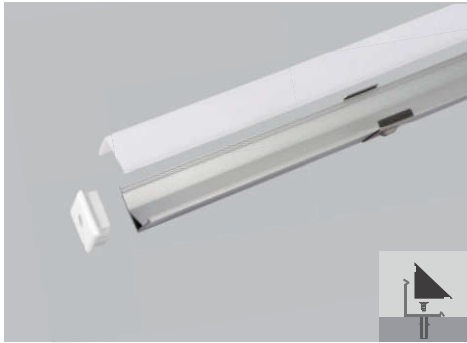

Silver
 Black

Material: AL6063-T5
Surface: Anodized/ Painting
PC cover: Diffuser/Transparent/Opal
Lighting source width: 10 mm
Available lengths: 0.5-3m
Application: Commercial lighting / Indoor lighting
 Decorative design

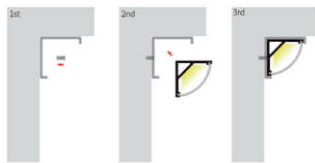
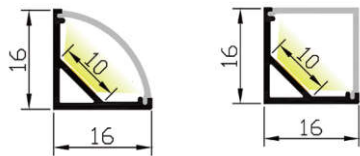

COVER



END CAP



CLIP



AP1813



Silver

Material: AL6063-T5
Surface: Anodized/ Painting
PC/ PMMA cover: Diffuser /Transparent /Opal
Lighting source width: 15 mm
Available lengths: 0.5-3m
Application: Commercial lighting / Indoor lighting



COVER



END CAP



CLIP



AP2613

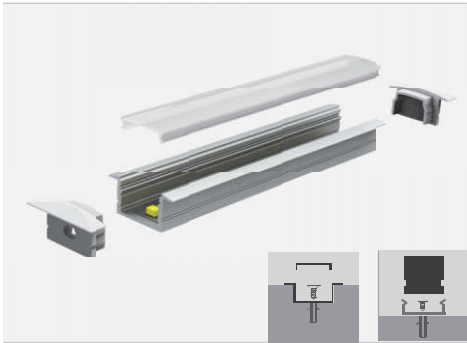

Silver
 Black

Material: AL6063-T5
Surface: Anodized/ Painting
PC/ PMMA cover: Diffuser /Transparent /Opal
Lighting source width: 15 mm
Available lengths: 0.5-3m
Application: Commercial lighting / Indoor lighting

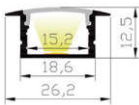

COVER



END CAP



CLIP



AP2810

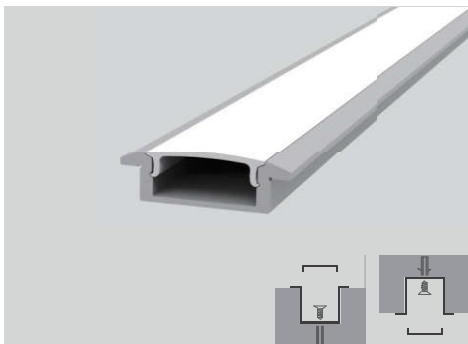

Silver

Material: AL6063-T5
Surface: Anodized/ Painting
PC cover: Diffuser/Transparent/Opal
Lighting source width: 18mm
Available lengths: 0.5-3m
Application: Commercial lighting / Indoor lighting
 Decorative design

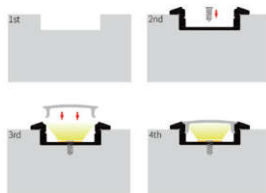
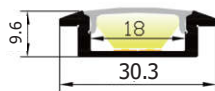

COVER



END CAP



AP2016

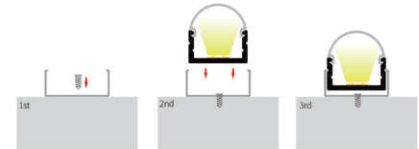
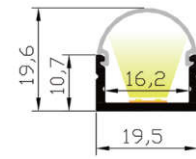

Material: AL6063-T5
 Surface: Anodized / Painting
 PC cover: Diffuser/Transparent/ Opal
 Lighting source width: 16 mm
 Available lengths: 0.5-3m
 Application: Commercial lighting / Indoor lighting
 Decorative design

COVER



END CAP



CLIP



AP1930



Cabinet used

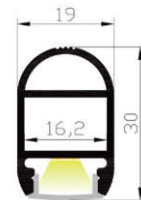

Silver
 Black
 White

Material: AL6063-T5
 Surface: Anodized / Painting
 PC/ PMMA cover: Diffuser/Transparent/ Opal
 Lighting source width: 16 mm
 Available lengths: 0.5-3m
 Application: Commercial lighting / Indoor lighting

COVER



HOLDER



END CAP



AP5035

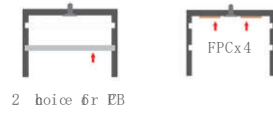
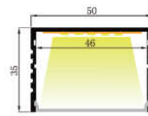
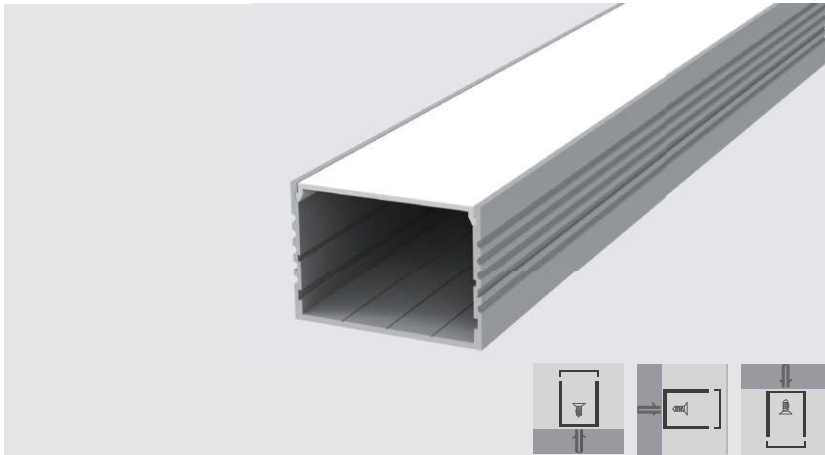

Silver

Material:	AL6063T5
Surface:	Anodized
PC cover:	Diffuser
Power:	0-50W/m
Lumens:	3500lm/m
Lighting source width:	10 mm x 4 pcs
Available lengths:	0.5-3m
Application:	Commercial lighting/ Indoorlighting

COVER



END CAP

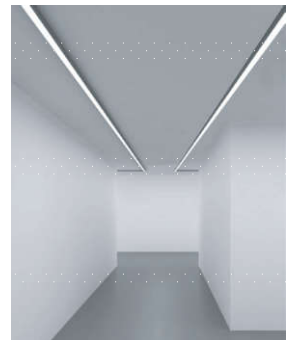

AP6332

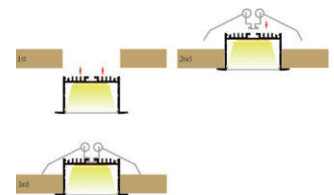
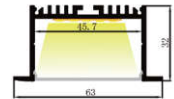
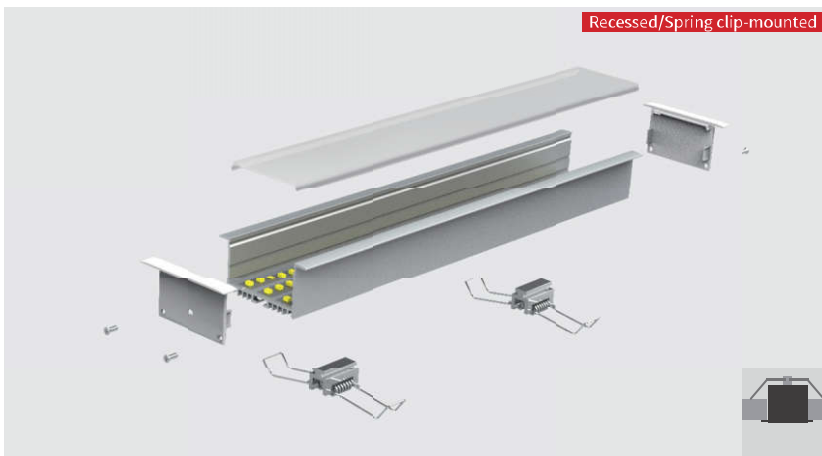

Silver

Material:	AL6063T5
Surface:	Anodized/ Painting
PC cover:	Diffuser
Power:	0-50W/m
Lumens:	4000lm
Lighting source width:	10 mm x 4 pcs
Available lengths:	0.5-3m
Application:	Commercial lighting/ Indoorlighting

COVER



END CAP



CLIP



AP2411



Silver
 Black

Material: AL6063-T5
 Surface: Anodized/ Painting
 PC cover: Transparent /Opal
 Power: 0-15W/m
 Lumens: 1000lm/m
 Lighting source width: 8mm x1pcs
 Available lengths: 0.5-3m
 Application: Commercial lighting/ Indoorlighting

COVER

END CAP



LT8050



Stairs lighting
Up and down both sides light emitting
Round surface design, Sliding preventing design

Silver
 Black
 White

Material: AL6063-T5
 Surface: Anodized/ Painting
 PC cover: Diffuser /Transparent /Opal
 Power: 0-15W/m
 Lumens: 1000lm/m
 Lighting source width: 13 mm x1pcs
 Available lengths: 0.5-3m
 Application: Commercial lighting/ Indoorlighting

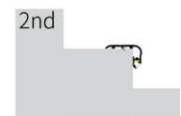
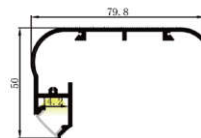

COVER

END CAP



AG1710



Silver
 Black

Material: AL6063-T5
Surface: Anodized/ Painting
PC/ PMMA cover: Diffuser /Transparent /Opal
Lighting source width: 8mm
Available lengths: 0.5-3m
Application: Commercial lighting / Indoor lighting

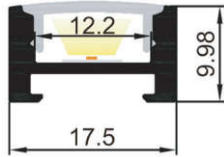

COVER



END CAP



MAGNET



AP2621

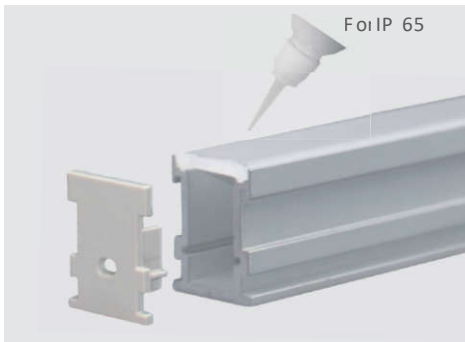

Silver

Material: AL6063-T5
Surface: Anodized/ Painting
PC cover: Diffuser/Transparent/Opal
Lighting source width: 12 mm
Available lengths: 0.5-3m
Application: Commercial lighting / Indoor lighting
 Decorative design

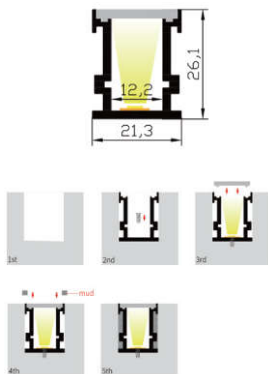

COVER



END CAP

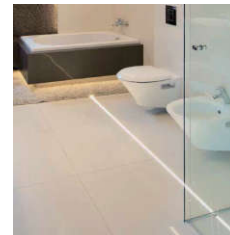

LO6060



Silver
 Black
 White

Material: AL6063-T5
Surface: Anodized/ Painting
PC/ PMMA cover: Diffuser
Lighting source width: 39mm
Available lengths: 0.5-3m
Application: Commercial lighting / Indoor lighting

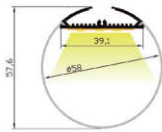

COVER



END CAP



PENDANT



AW1910



Silver

Material: AL6063-T5
Surface: Anodized/ Painting
PC cover: Diffuser
Lighting source width: 12mm
Available lengths: 0.5-3m
Application: Commercial lighting / Outdoor lighting
 Decorative design

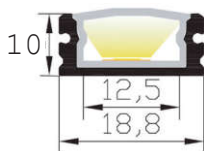

COVER



END CAP



CLIP



HEAT SINK



AP6214



RECESSED TRIMLESS DESIGN

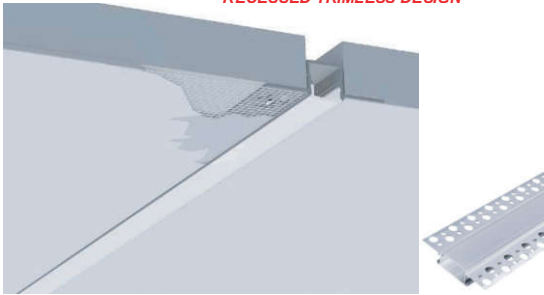

 Silver

Material: AL6063-T5
Surface: Anodized
PC cover: Opal
Lighting source width: 12mm
Available lengths: 0.5- 3m
Application: Cabinet lighting / Wardrobe lighting

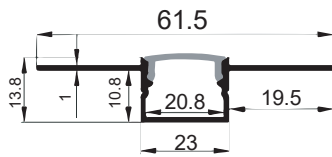

COVER



END CAP



AP7676

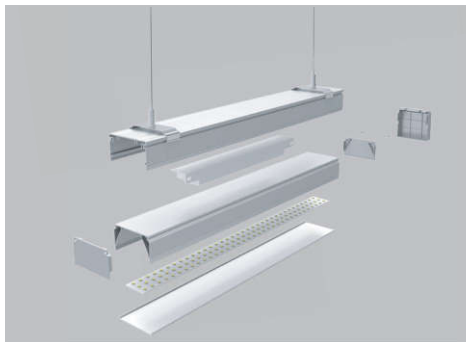

 Silver

Material: AL6063-T5
Surface: Anodized
PC cover: Opal
Lighting source width: 10mm
Available lengths: 0.5- 3m
Application: Cabinet lighting / Wardrobe lighting

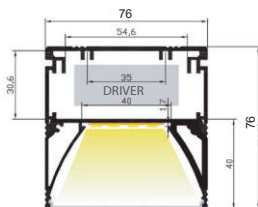

COVER



END CAP



PENDANT



LSLY-COB480

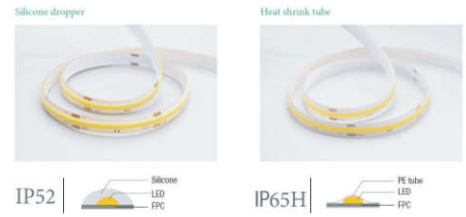
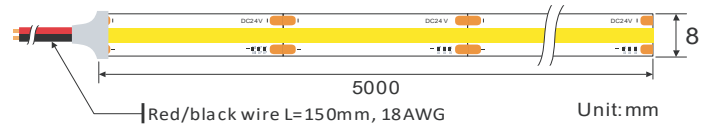

Product Photometrics (Data base on IP20 CRI>90)

Part Number	CCT (K)	Low power (5w/m)		Medium power (10w/m)		High power(15w/m)	
		Lumen (lm/m)	Efficacy (lm/w)	Lumen (lm/m)	Efficacy (lm/w)	Lumen (lm/m)	Efficacy (lm/w)
▶ LSLY-COB480-27K	2700±100K	481.9	96.38	957.3	95.73	1418	94.53
▶ LSLY-COB480-30K	3000±150K	519.1	103.82	1029.0	102.90	1527	101.80
▶ LSLY-COB480-40K	4000±250K	575.0	115.00	1138.0	113.80	1690	112.67
▶ LSLY-COB480-60K	6500±500K	560.7	112.40	1124.0	112.14	1672	111.46

LSSC-22161B

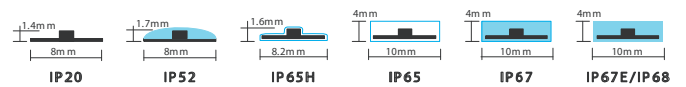
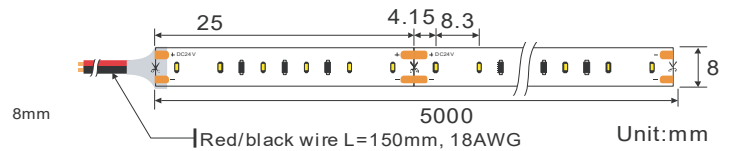

Product Photometrics (Data base on IP20 CRI>95)

CCT (K)	Lumen (lm/m)	Efficacy (lm/w)	CRI	R9	TM-30-15	
					Rf (Fidelity)	Rg (Gamut)
2500±100	761.3	79.3	95.2	92.2	95.3	99.8
2700±100	772.8	80.5	95.8	93.4	95.6	99.3
3000±100	895.7	93.3	96.1	95.9	95.9	101.1
3500±150	896.6	93.4	96.7	96.9	96.9	102.4
4000±200	913.9	95.2	96.3	95.2	96.9	103.7
5000+500	921.6	96.0	95.1	95.2	96.7	102.1
6000+500	928.3	96.7	95.0	93.1	96.1	101.1

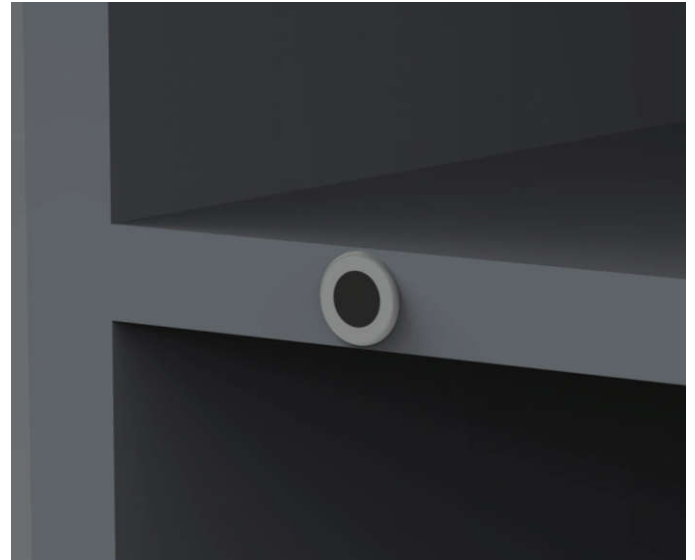
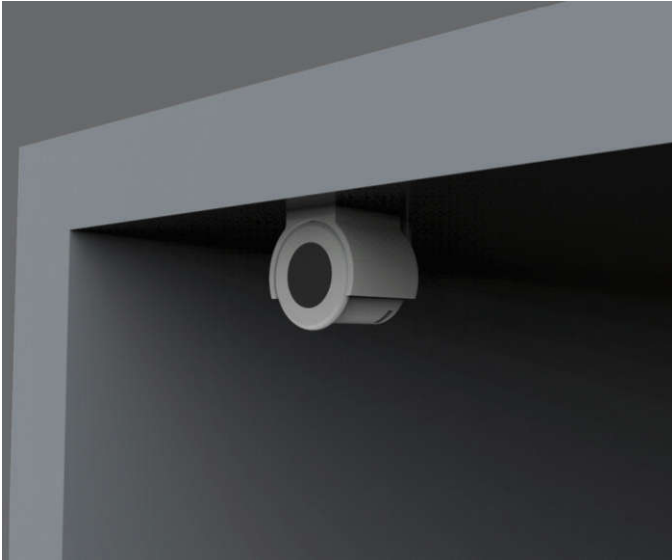

IR1102

A contactless electronic switch with IR sensor technology. The sensing distance is 5-8cm. The switch is mounted at the back side of door sheet, LED lamp will be switched on and off by opening and closing the door panel.

Technical details

Item No.	Size(mm)	Voltage(VDC)	Power(W)	Detection distance
IR1102.QB.01	φ 15x13	12/24	20/60	5- 8cm
IR1102.MB.01				



IR1102QB-Recessed



IR1102QB-Surface Mount

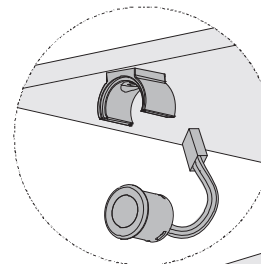
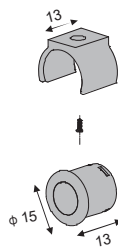

1

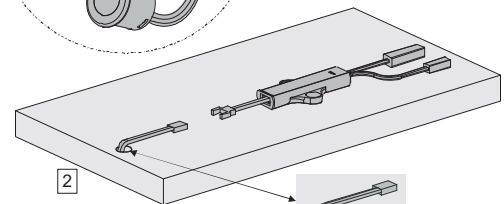

2

Threaded hole: φ 8mm

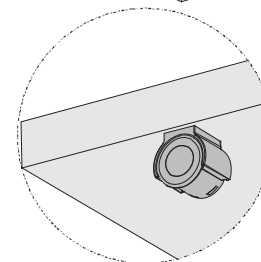

3

All unit in mm

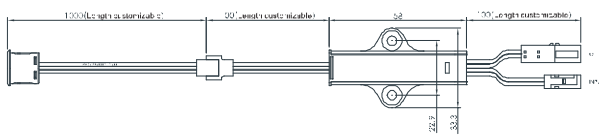

Connection Diagram

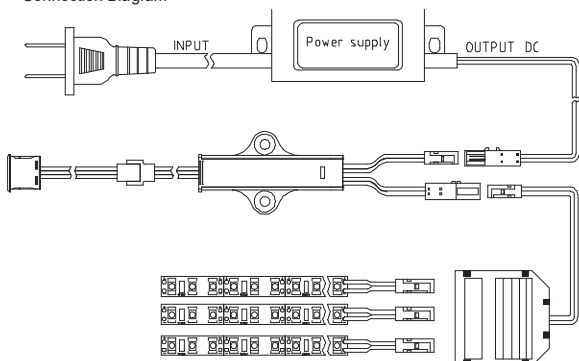

Available in double and triple trigger

